



LG Therma V

# Aperçu de la gamme Therma V



PAC Monobloc  
Moyenne Température



PAC Split  
Moyenne Température



PAC Split  
Haute Température

**NEW**



PAC Monobloc  
R32



























PAC Split  
ECS intégrée

**NEW**

**NEW**

# Aperçu de la gamme Therma V

		Refrigerant	Capacity (kW)	5	7	9	12	14	16	
Monobloc Mid Temp. (65°C)		R32	1ø 220V	 HM051M.U43	 HM071M.U43	 HM091M.U43	 HM121M.U33	 HM141M.U33	 HM161M.U33	
			3ø 380V				 HM123M.U33	 HM143M.U33	 HM163M.U33	
Spilt Low Temp. (57°C)	Hydro Box Type	R410A	1ø 220V	 HU051.U43	 HU071.U43	 HU091.U43	 HU121.U33	 HU141.U33	 HU161.U33	
			3ø 380V				 HU123.U33	 HU143.U33	 HU163.U33	
	DHW Tank Integrated Type		1ø 220V				 HU091.U43	 HU121.U33	 HU141.U33	 HU161.U33
			3ø 380V				 HU123.U33			 HU143.U33
Split High Temp. (80°C)		R410A + R134a	1ø 220V							 HU161H.U32

## Focus Nouveautés 2018



---

PAC Monobloc  
R32

**NEW**



## **THERMA V** **Monobloc**

SCOP (35°C)  : 4.45 / A+++









Plage de fonctionnement  : -25 ~ 35°C

Nouvelle télécommande : RS3

Plus léger : 5,7,9kW : 90kg

Impact environnemental réduit



	Refrigérant	Capacité (kW)	5	7	9	12	14	16
Monobloc Moyenne Temp. (65°C)	R32	1ø 220V	 HM051M.U43	 HM071M.U43	 HM091M.U43	 HM121M.U33	 HM141M.U33	 HM161M.U33
		3ø 380V				 HM123M.U33	 HM143M.U33	 HM163M.U33

## Differences between R410A Monobloc and R32 Monobloc

Categories	Items	R410A Monobloc	R32 Monobloc	Remark
Efficiency	SCOP (@ LWT 35°C) / Class	4.16 / A++ (16kW / 3Ph)	4.45 / A+++ (All range)	Increased SCOP
Component	Refrigerant	R410A	R32	Lower GWP application
	Line up	1Ph : 3, 5, 7, 9, 12, 14, 16kW 3Ph : 12, 14, 16kW	1Ph : 5, 7, 9, 12, 14, 16kW 3Ph : 12, 14, 16kW	3kW drop
	Compressor	Rotary	New Type Scroll Compressor	New Tech Application
	Pump (Brand)	Wilo	Grundfos	EU Preference
	Electric Heater	Internal & Default	<b>External &amp; Option (3, 6kW)</b>	Option Accessory
	PHEX	Gold Fin	Black Fin	Highly corrosion resistant
	Dimension H x W x D (mm)	5,7,9kW : 907 x 1,239 x 390 12,14,16kW : 1,450 x 1,239 x 390	5,7,9kW : 907 x 1,242 x 390 12,14,16kW : 1,450 x 1,242 x 390	Almost same dimension
	Weight	5,7,9kW : 97 ~ 99kg 12,14,16kW: 141 ~ 145kg	5,7,9kW : 90kg 12,14,16kW: 135kg	Reduced weight
	Interface (Remote Controller)	RS2	RS3	Interface change
Performance	Operation Range (Heating)	-20 ~ 35°C	<b>-25 ~ 35°C</b>	Range wider
	Max. Leaving water temperature	57°C	<b>65°C</b>	
	Heating performance (@ LWT 55°C)	64% at -7 °C (16kW / 3Ph)	100% @ -7 °C (All range) 81% @ -15°C (16kW / 3Ph)	Low Ambient Performance Improved
	Noise (Max. Sound Power Level for Heating)	5kW : 63dB / 7kW : 65dB / 9kW : 67dB / 12,14,16kW: 68dB	5,7,9kW : 60dB 12,14,16kW: 63dB	5,7,9kW : Max. 7dB ↓ 12,14,16kW: 5dB ↓

# Nouveauté 2018 : Therma V – Monobloc R32

The ErP directive is a key factor of selecting heating device in Europe heating market.  
 The R32 Monobloc type has an energy label rating A+++<sup>1)</sup> in ErP energy labelling regulation.

## SCOP

### SCOP improvement

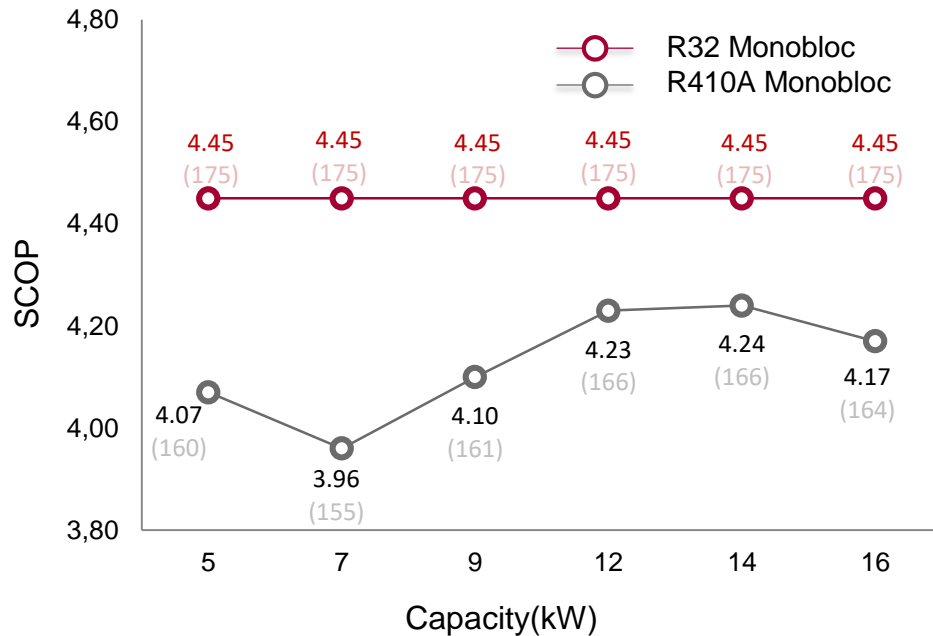

※ Test Condition  
 Test procedure follows EN14825 (Average LWT 35°C)  
 Based on the single phase model line up

## ErP Energy Labeling

### Heating

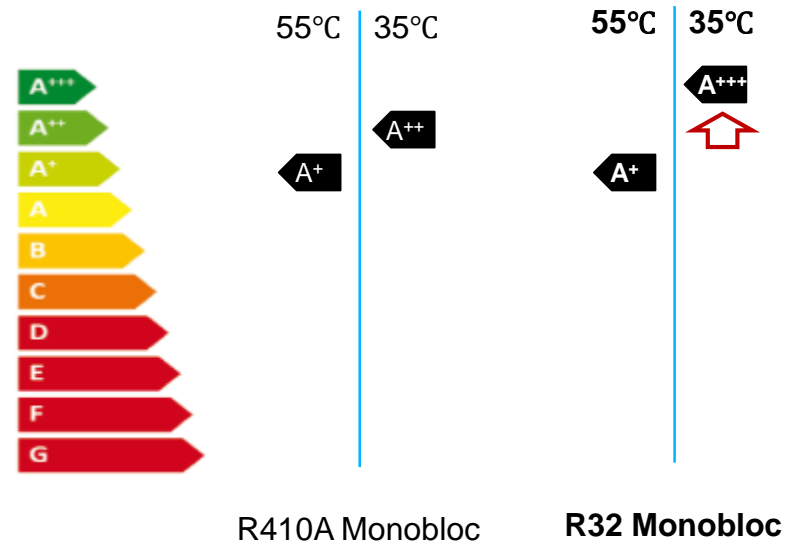

1) Seasonal space heating efficiency class at water outlet 35°C  
 ※ This A+++ label is available from 26, Sep. 2019.

# Nouveauté 2018 : Therma V – Monobloc R32

The R32 Monobloc provides excellent heating performance – especially at Low Ambient Temperature.

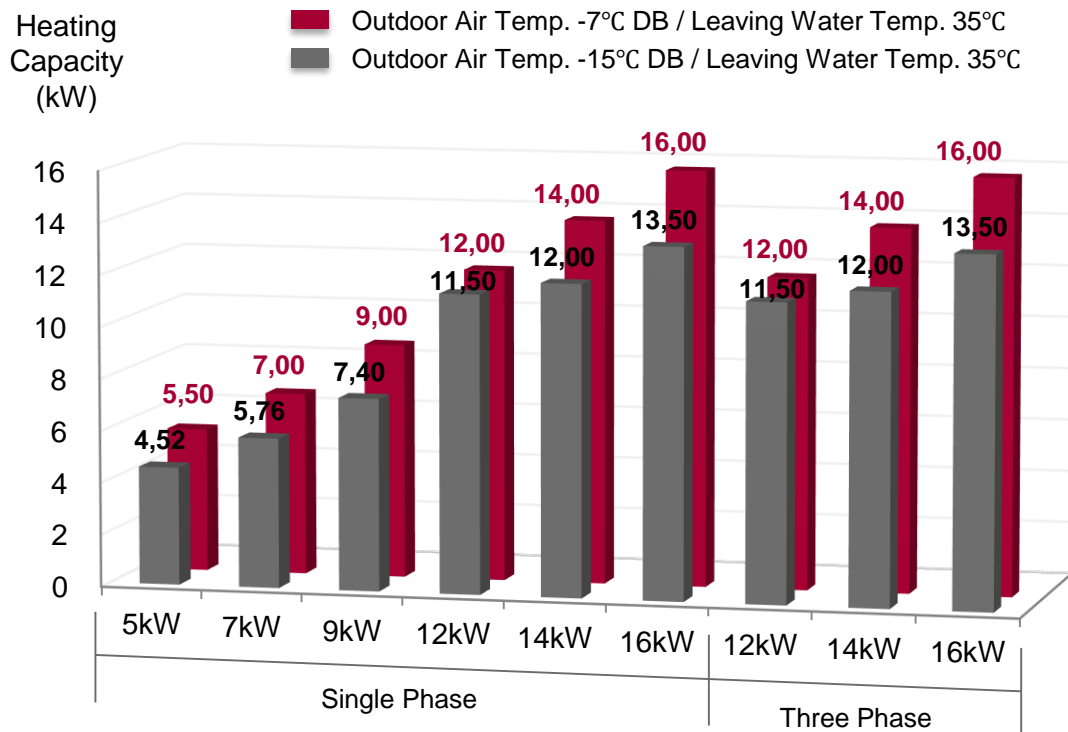

**Heating Capacity of R32 Monobloc at Low Ambient Temperature**

Heating Capacity at OAT -7°C DB is same as normal capacity<sup>1)</sup> and Heating Capacity at OAT -15°C DB is more than 80% of normal capacity.

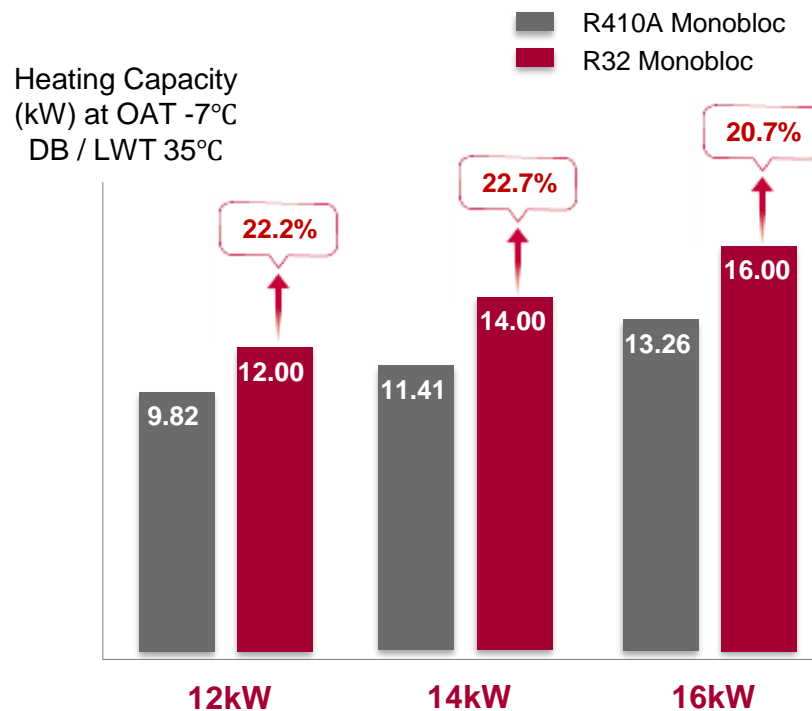

※ Based on the Monobloc 12kW (3Ph) / 14kW (3Ph) / 16kW (3Ph) models

Heating capacity of R32 Monobloc At Low Ambient Temperature is improved more than 20% compared to R410A Monobloc.

1) Normal : Outdoor air temperature 7°C DB / 6°C WB, Water outlet temperature 35°C



# Nouveauté 2018 : Therma V – Monobloc R32

The R32 Monobloc reduces noise level compared to previous models.

## Operation Noise for Heating

(Unit : dB(A))

Q'ty of Fan		1 Fan			2 Fans		
		5	7	9	12	14	16
R32 Monobloc	Sound Pressure Level (SPL) <sup>1)</sup>	52	52	52	55	55	55
	Sound Power Level (SWL)	60	60	60	63	63	63
R410A Monobloc	Sound Power Level (SWL)	63	65	67	68	68	68

## Sound Pressure Level Comparison

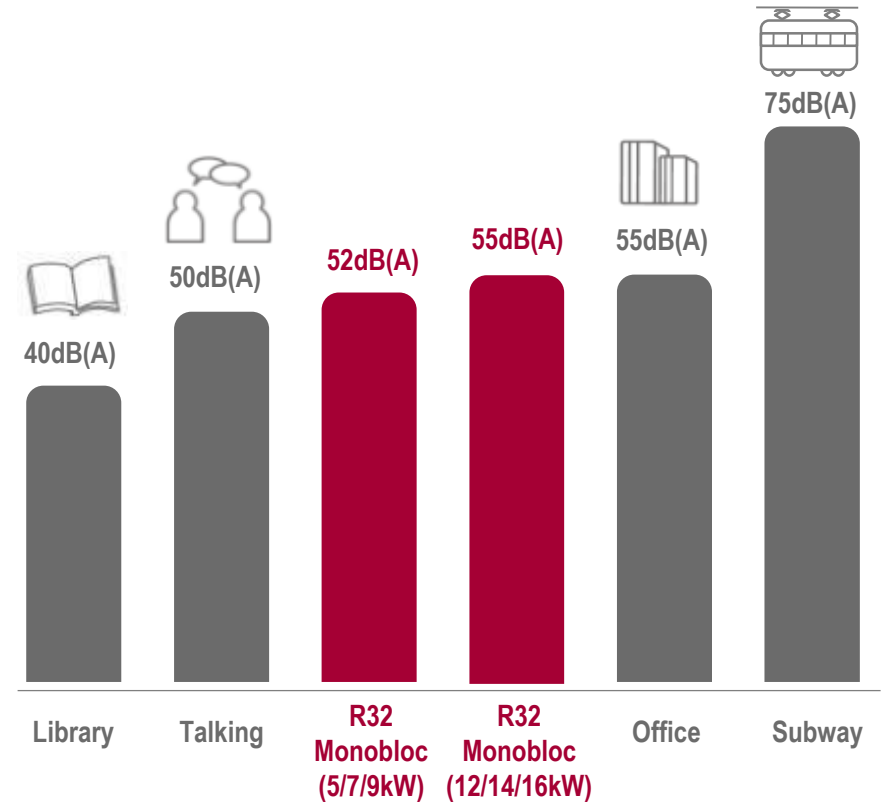

1) This Sound Pressure Level is converted from Sound Power Level at 1m distance away.

# 2nd Heating Circuit

2 Zone (Day/Night Zone) Temperature Control through separate heating circuits is possible with mixing valve kit.

## 2 Zone Temperature Control

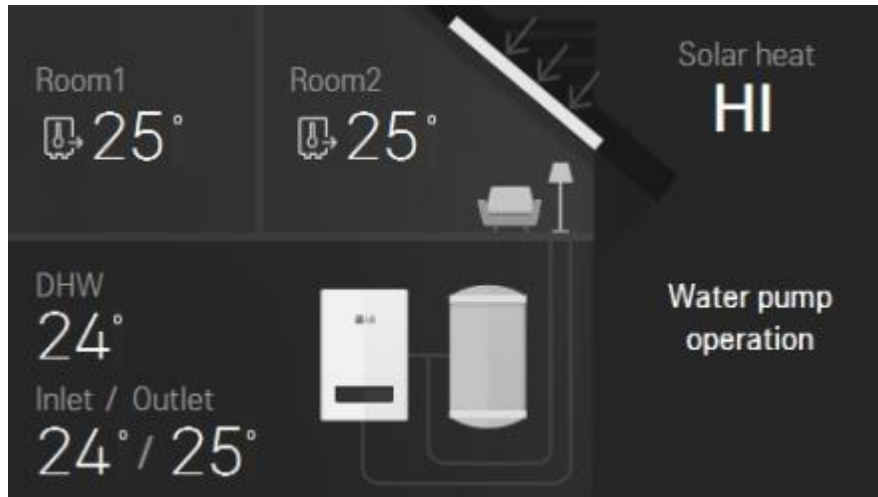

Setting Night Zone Temp.



Setting Day Zone Temp.

## 2nd Heating Circuit Diagram

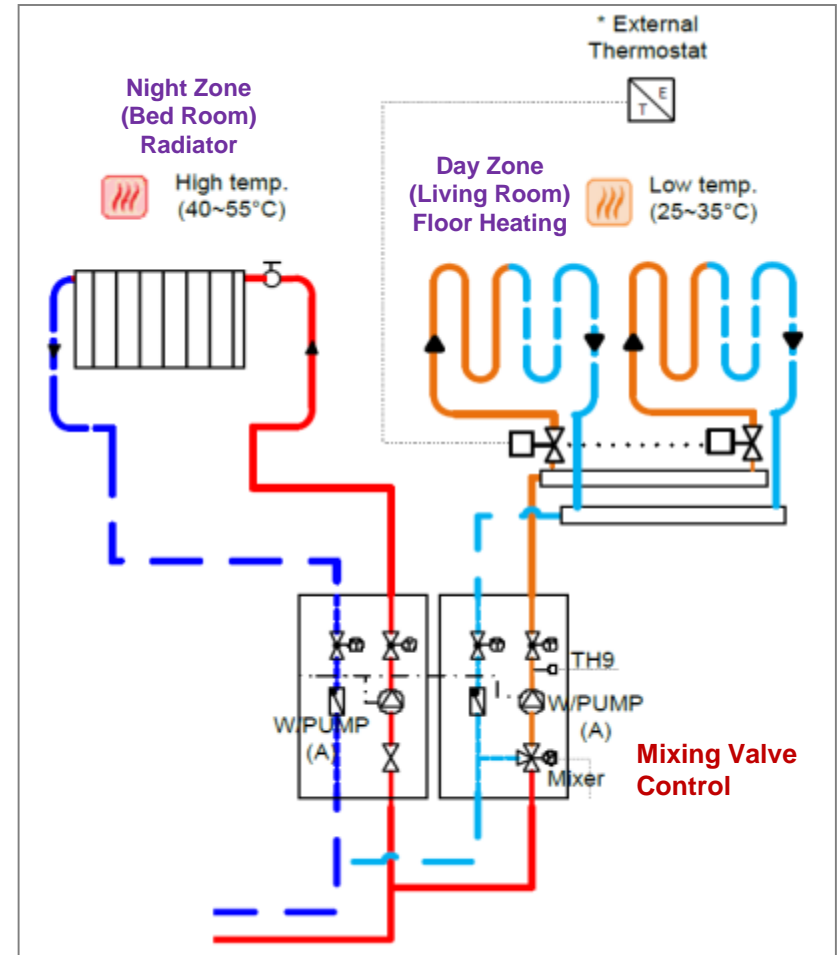

## Various Temperature Control Options

Various Temperature Control Options are possible for User's comfort and convenience. Especially for European life style that thermal comfort is preferred, Water Temp. + Room Temp. Control function is added.

① Leaving Water Temperature Control

**New**

② Entering Water Temperature Control

③ Room Temperature Control

**New**

④ Water Temp. + Room Temp. Control

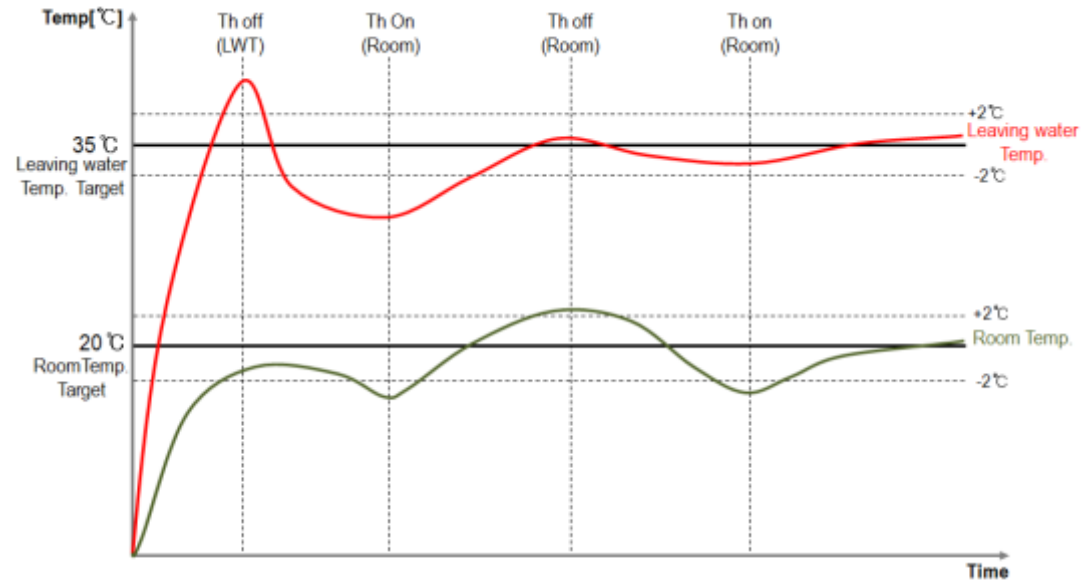

# Ocean Black Fin

'Ocean Black Fin' heat exchanger is highly corrosion resistant, designed to perform in corrosive environments such as contaminated and humid condition

 **Longer Lifespan, Lower Operational Costs**  **Strengthened corrosion resistant coating**

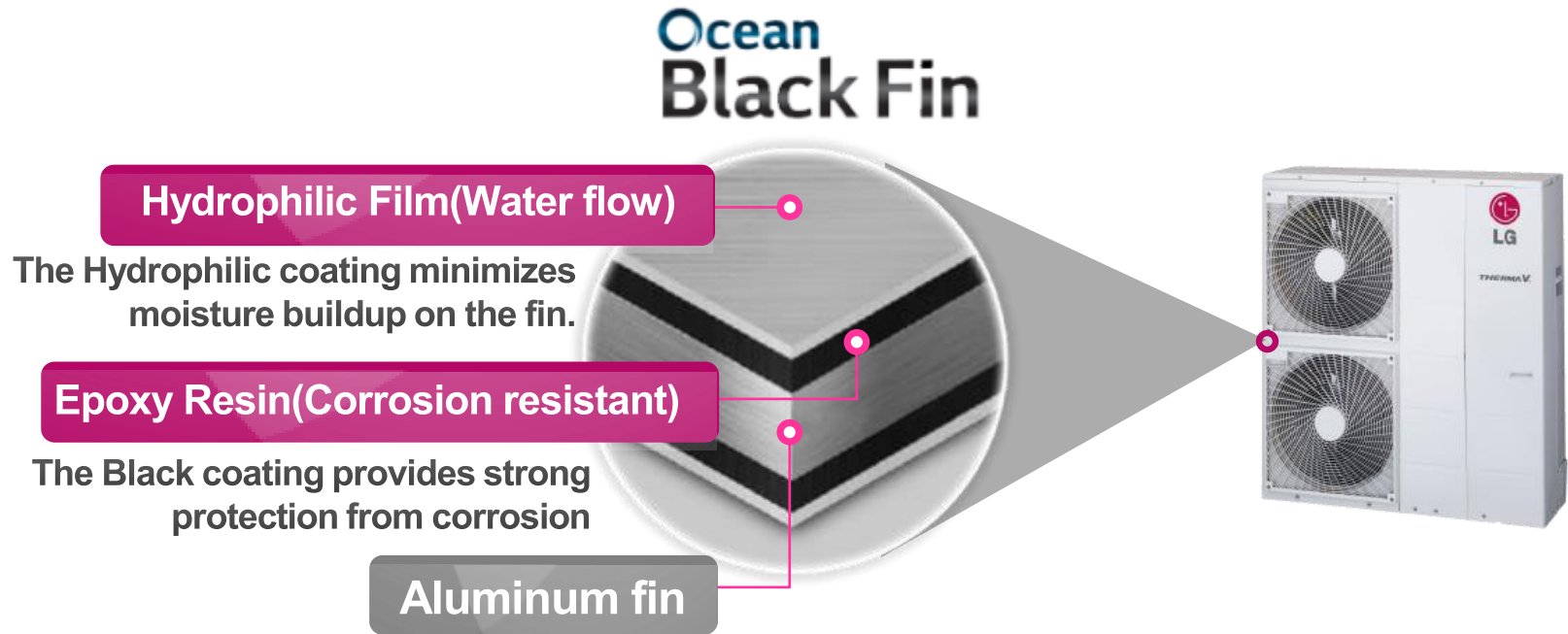

# Pressure Control & Quick Operating Response

Pressure Control secures faster and more exact response than temperature control, so it reduces the time to reach the target water temperature by 44%.

## Faster and More exact with Pressure Control

Quick response due to sensing with ready for operation.  
Ensures to reach target performance point without failing to keep a reliable operation.

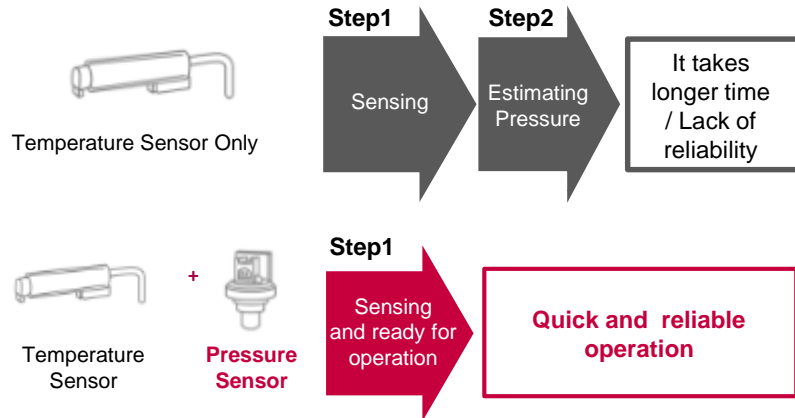
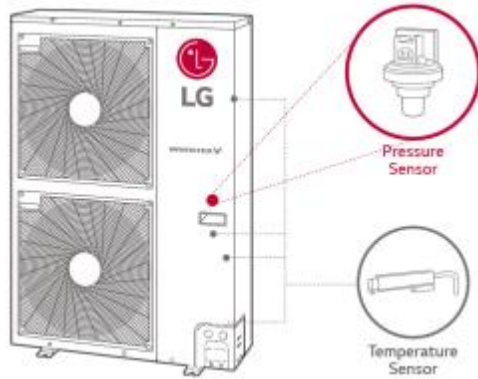

## Quick Reaching to Target Temperature

Pressure control takes up to 44% less time to reach the desired water temperature with a high level of accuracy and stability

