

INSTALLATION NOTES

Applicable for the following catalog numbers ¹:

- MC5c240VYX * 06R1 (CDN 1EL/06M 240/416VX)
- MC5c240VYX * 12R1 (CDN 1EL/12M 240/416VX)
- MC5c240VYX * 18R1 (CDN 1EL/18M 240/416VX)
- MC5c240VYX * 24R1 (CDN 1EL/24M 240/416VX)

* = "L" for 0.1 Amp inputs or "H" for CL10 (5 Amp) inputs.

¹ Also applicable when the same meter model number has the suffix: M, RS or P.

CRITICAL: The installation of the current transformer must be correct or the meter will not read properly. The load-current carrying wires must pass through the CT in the correct orientation, and the CT wires must be connected to the proper MCI screw terminals. Please see wiring diagram for reference.

Current transformers (CTs) are used to measure the current drawn by the loads to be metered. CTs must be all 0.1A or 5A and cannot be mixed on the same meterhead. Within the meter, the current reading from the CT is combined with the voltage reading for the correct voltage phase to calculate the energy reading. CTs must be in phase with the reference voltage. The MCI inputs are each associated with a particular voltage phase in an A-B-C order. Input 1 is a phase A CT, input 2 is a phase B CT, input 3 is a phase C CT, input 4 is a phase A CT, and so on in A-B-C-A-B-C order.

For example, a CT which measures a load supplied by phase A must be installed on CT1, CT4, CT7, etc.. Current transformers which measure a load supplied by phase B must be installed on CT2, CT5, CT8, etc.. Lastly, current transformers which measure a load supplied by phase C must be installed on CT3, CT6, CT9, etc.

1. For the catalog numbers specified above, each A, B, and C phase is a single meter point (see Table 1 for full listing):
 - Meter #1 (M#1) is CT1
 - Meter #2 (M#2) is CT2
 - repeat for M#3 to M#24
2. After completing all CT terminations, connect the four (4) current connectors for the MCI board to the meterhead and then remove shorting links for all meter points that are in use.
3. Follow local codes for installation requirement, e.g. conduit, fused disconnect, distance, and wiring.
4. Installation of 0.1A ("L") inputs and CL10 or 5A ("H") inputs are the same.



CAUTION: If breakers are energized, shorting links must be installed before:

- a) disconnecting the CT headers or
- b) replacing or installing meter heads on the panel.

WARNING: Bodily injury or damage may result if shorting links are not installed.

Meter # (M#)	MCI Board CT #	Reference Voltage Phase
1	1	A
2	2	B
3	3	C
4	4	A
5	5	B
6	6	C
7	7	A
8	8	B
9	9	C
10	10	A
11	11	B
12	12	C
13	13	A
14	14	B
15	15	C
16	16	A
17	17	B
18	18	C
19	19	A
20	20	B
21	21	C
22	22	A
23	23	B
24	24	C

Table 1. Phase Association Table

 Qualogic Controls Corporation		TITLE	
SIGNATURES		3-PHASE, 4-WIRE 1EL WIRING DIAGRAM 	
MODEL	JREA	DATE	07/09/08
APPROVED	RSAN	DATE	07/10/08
APPROVED	JKIM	DATE	07/10/08
APPROVED	BDUA	DATE	07/10/08
SIZE: DRAWING		17-MC5c3P4WY1ELCDNR1	
SCALE:		REV 1.1.R	
			SHEET 1 of 3

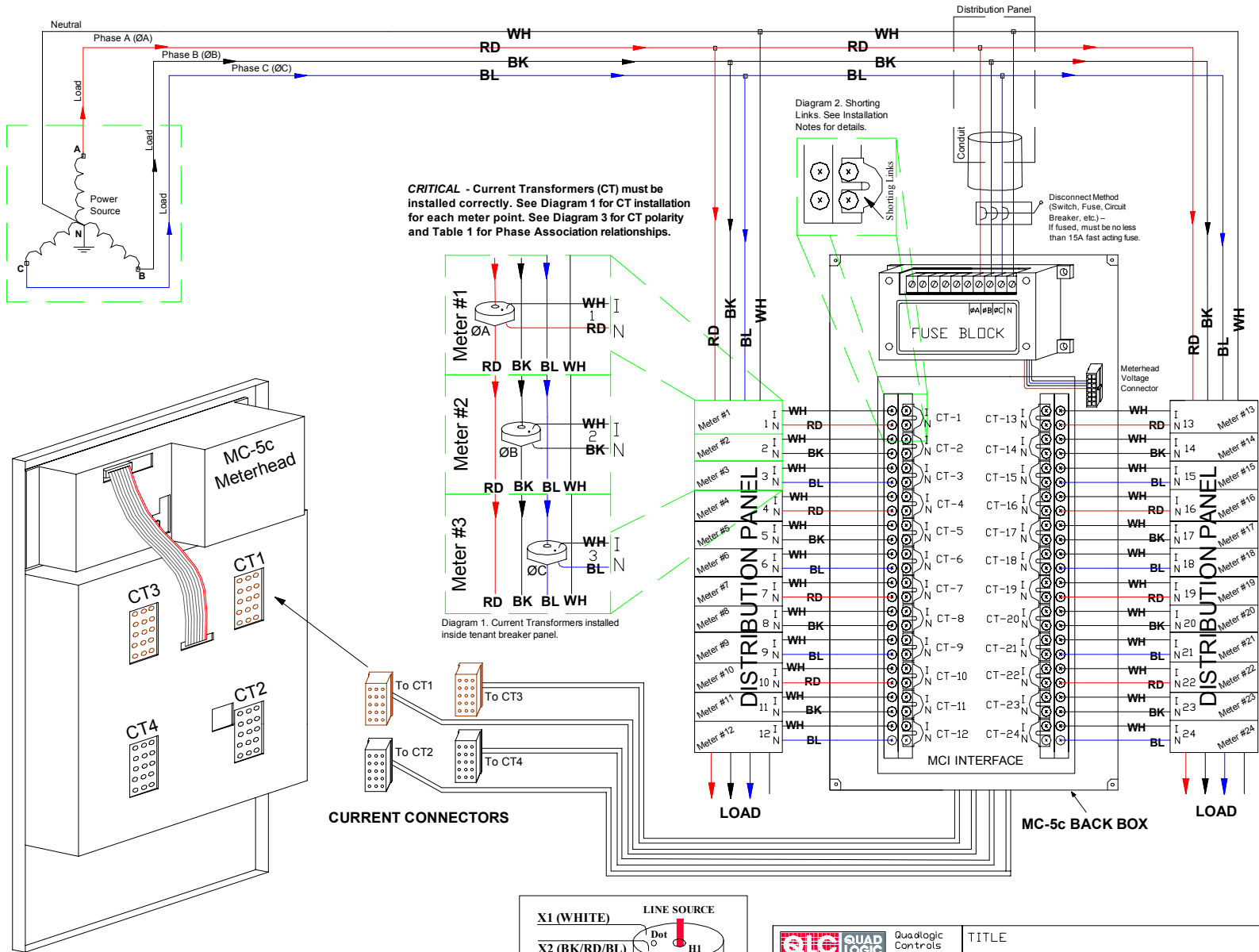

QC QUAD LOGIC Quadlogic Controls Corporation		TITLE	
SIGNATURES		DATE	
MODEL	JREA	07/09/08	
APPROVED	RSAN	07/10/08	
APPROVED	JKIM	07/10/08	
APPROVED	BDUA	07/10/08	

3-PHASE, 4-WIRE 1EL WIRING DIAGRAM		REV 1.1.R
17-MC5c3P4WY1ELCDNR1		
SCALE:		SHEET 2 of 3



BEFORE READING THE DISPLAY FOR ANY MC5 PRODUCT

CAUTION: When reading the meter display, all consumption and demand values must be multiplied by the correct multiplier to calculate true value. This includes all register values (kWh, kW, kVARHLg, kVARHLd, etc.) and Phase Diagnostic values (real time Amps, Watts, etc.).

Volts, phase angle, frequency and power factor are displayed on the LCD as their true values and should not be multiplied.

The multiplier value is dependent upon the ratio of the external Current Transformers (CTs) and can be different for different meter points. Please consult Table 1 CT Multipliers for the appropriate value dependent upon the rating (or size) of the CT.

HOW CT MULTIPLIERS ARE CALCULATED:

0.1AMP CTs

The multiplier values for CTs with 0.1A secondary ratings are derived by dividing the primary side rating by 100. For example, a 50:0.1A-rated CT will have a multiplier of $50 \div 100$, which is 0.50. A 100:0.1A rated CT will have a multiplier of $100 \div 100$ which is 1.)

5AMP CTs

For CTs with 5A secondary ratings, the multipliers are derived by dividing the primary side rating by 5. For example, a 200:5A-rated CT will have a multiplier of $200 \div 5$, which is 40.

EXAMPLE:

Meter point with 400:0.1A CT

LCD reading for meter is 3422.119kWh

The correct cumulative consumption (kWh) for this meter is **13688.476** kWh.

($400 \div 100 = 4$. Multiply face value for consumption and demand values by 4. $3422.119 \times 4 = 13688.476$)



NOTE: Failure to use the appropriate multiplier will result in an incorrect diagnosis of the meter's functionality and incorrect revenue billing.

Meter Voltage Ratings	CT Rating	Multiplier for 0.1A CT	Multiplier for 5.0A CT
FOR 120V, 208V, 240V (Wye) 277V, 347V, 416V, 480V, 600V	50A	x0.5	x10.0
	100A	x1.0	x20.0
	200A	x2.0	x40.0
	400A	x4.0	x80.0
	600A	x6.0	x120.0
	800A	x8.0	x160.0
	1200A	x12.0	x240.0
	1500A	x15.0	x300.0
	1600A	x16.0	x320.0
	2000A	x20.0	x400.0
	3000A	x30.0	x600.0
	3200A	x32.0	x640.0
4000A	x40.0	x800.0	

FOR 240V (Split-phase)	100A	x0.5	x20.0
	200A	x1.0	x40.0

Table 1. CT Multipliers

REVISIONS			
REV.	DESCRIPTION	DATE	APPROVED

		Quadlogic Controls Corporation TITLE: 3-PHASE, 4-WIRE 1EL WIRING DIAGRAM 
SIGNATURE'S		DATE
MODEL	JREA	07/09/08
APPROVED	RSAN	07/10/08
APPROVED	JKIM	07/10/08
APPROVED	BDAU	07/10/08
SIZE: DRAWING		REV
17-MC5c3P4WY1ELCDNR1		1.1.R
SCALE:		SHEET 3 of 3

INSTALLATION NOTES

Applicable for the following catalog numbers ¹:

- MC5c120VX * 03R (CDN 2EL/3M 120/208VX)
- MC5c120VX * 06R (CDN 2EL/6M 120/208VX)
- MC5c120VX * 09R (CDN 2EL/9M 120/208VX)
- MC5c120VX * 12R (CDN 2EL/12M 120/208VX)

* = "L" for 0.1 Amp inputs or "H" for CL10 (5 Amp) inputs.

¹ Also applicable when the same meter model number has the suffix: M, RS, or P.

CRITICAL: The installation of the current transformer must be correct or the meter will not read properly. The load-current carrying wires must pass through the CT in the correct orientation, and the CT wires must be connected to the proper MCI screw terminals. Please see wiring diagram for reference.

Current transformers (CTs) are used to measure the current drawn by the loads to be metered. CTs must be all 0.1A or 5A and cannot be mixed on the same meterhead. Within the meter, the current reading from the CT is combined with the voltage reading for the correct voltage phase to calculate the energy reading. CTs must be in phase with the reference voltage. The MCI inputs are each associated with a particular voltage phase in an A-B-C order. Input 1 is a phase A CT, input 2 is a phase B CT, input 3 is a phase C CT, input 4 is a phase A CT, and so on in A-B-C-A-B-C order.

For example, a CT which measures a load supplied by phase A must be installed on CT1, CT4, CT7, etc.. Current transformers which measure a load supplied by phase B must be installed on CT2, CT5, CT8, etc.. Lastly, current transformers which measure a load supplied by phase C must be installed on CT3, CT6, CT9, etc.

1. For the catalog numbers specified above, each A-B, C-A, and B-C combination is a single meter point (see Table 1 for full listing):

- Meter #1 (M#1) is CT1 and CT2
- Meter #2 (M#2) is CT3 and CT4
- repeat for M#3 to M#12

2. After completing all CT terminations, connect the four (4) current connectors from the MCI board to the meterhead and then remove shorting links for all meter points that are in use.

3. Follow local codes for installation requirement, e.g. conduit, fused disconnect, distance, and wiring.

4. Installation of 0.1A ("L") inputs and CL10 or 5A ("H") inputs are the same.

5. For three (3), six (6), and nine (9) 3-phase metering points, model numbers:

- MC5c120VX * 03R
- MC5c120VX * 06R
- MC5c120VX * 09R

use meter points M#1-M#3, M#1-M#6, and M#1-M#9, respectively. M#4-M#12, M#7-M#12, and M#10-M#12 are not functional for three (3), six (6), and nine (9) 3-phase metering points, respectively.



CAUTION: If breakers are energized, shorting links must be installed before:

- a) disconnecting the CT headers or
- b) replacing or installing meter heads on the panel.

WARNING: Bodily injury or damage may result if shorting links are not installed.

Meter # (M#)	MCI Board CT #	Reference Voltage Phase
1	1	A
	2	B
2	3	C
	4	A
3	5	B
	6	C
4	7	A
	8	B
5	9	C
	10	A
6	11	B
	12	C
7	13	A
	14	B
8	15	C
	16	A
9	17	B
	18	C
10	19	A
	20	B
11	21	C
	22	A
12	23	B
	24	C

Table 1. Phase Association Table

		QuadLogic Controls Corporation TITLE 1-PHASE, 3-WIRE 120/208V WIRING NETWORK DIAGRAM 
SIGNATURES		DATE
MODEL	JREA	07/09/08
APPROVED	RSAN	07/10/08
APPROVED	JKIM	07/10/08
APPROVED	BDUA	07/10/08
SIZE DRAWING		REV
17-MC5c120RES2ELCDNR1		1.1.R
SCALE:		SHEET 1 of 3

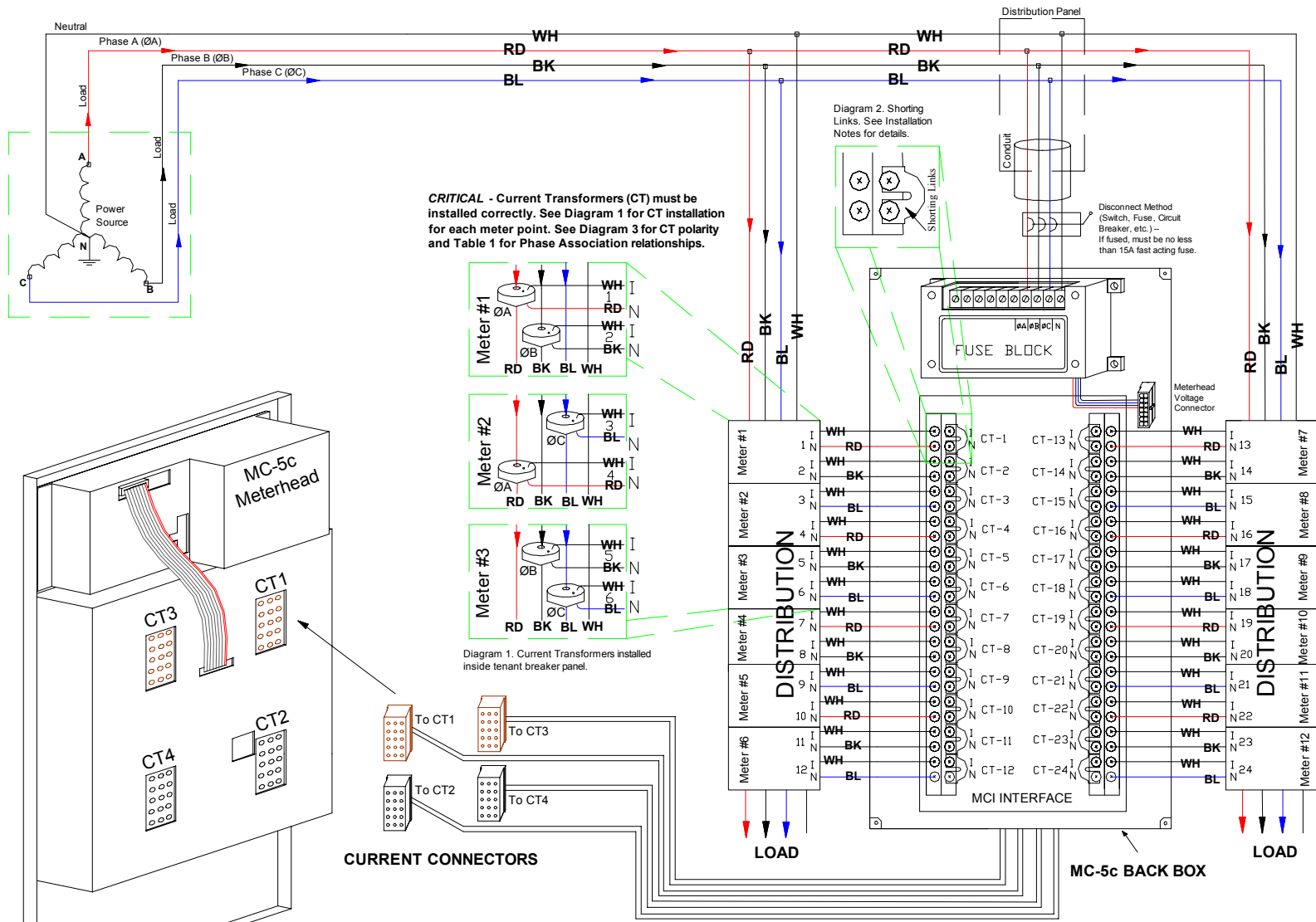

QUAD LOGIC Quadlogic Controls Corporation		TITLE	
SIGNATURES		DATE	
MODEL	JREA	07/09/08	
APPROVED	RSAN	07/10/08	
APPROVED	JKIM	07/10/08	
APPROVED	BDAU	07/10/08	SCALE:

1-PHASE, 3-WIRE 120/208V WIRING NETWORK DIAGRAM		REV
17-MC5c120RES2ELCDNR1		1.1.R
SHEET 2 of 3		

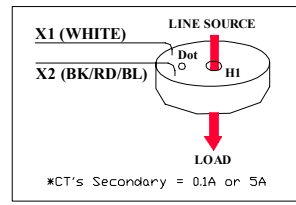

BEFORE READING THE DISPLAY FOR ANY MC-5c PRODUCT

CAUTION: When reading the meter display, all consumption and demand values must be multiplied by the correct multiplier to calculate true value. This includes all register values (kWh, kW, kVARHLg, kVARHLd, etc.) and Phase Diagnostic values (real time Amps, Watts, etc.).

Volts, phase angle, frequency and power factor are displayed on the LCD as their true values and should not be multiplied.

The multiplier value is dependent upon the ratio of the external Current Transformers (CTs) and can be different for different meter points. Please consult Table 1 CT Multipliers for the appropriate value dependent upon the rating (or size) of the CT.

HOW CT MULTIPLIERS ARE CALCULATED:

0.1AMP CTs

The multiplier values for CTs with 0.1A secondary ratings are derived by dividing the primary side rating by 100. For example, a 50:0.1A-rated CT will have a multiplier of $50 \div 100$, which is 0.50. A 100:0.1A rated CT will have a multiplier of $100 \div 100$ which is 1.

5AMP CTs

For CTs with 5A secondary ratings, the multipliers are derived by dividing the primary side rating by 5. For example, a 200:5A-rated CT will have a multiplier of $200 \div 5$, which is 40.

EXAMPLE:

Meter point with 400:0.1A CT

LCD reading for meter is 3422.119kWh

The correct cumulative consumption (kWh) for this meter is **13688.476** kWh.



($400 \div 100 = 4$. Multiply face value for consumption and demand values by 4. $3422.119 \times 4 = 13688.476$)

NOTE: Failure to use the appropriate multiplier will result in an incorrect diagnosis of the meter's functionality and incorrect revenue billing.

Meter Voltage Ratings	CT Rating	Multiplier for 0.1A CT	Multiplier for 5.0A CT
FOR 120V, 208V, 240V (Wye), 277V, 347V, 416V, 480V, 600V	50A	x0.5	x10.0
	100A	x1.0	x20.0
	200A	x2.0	x40.0
	400A	x4.0	x80.0
	600A	x6.0	x120.0
	800A	x8.0	x160.0
	1200A	x12.0	x240.0
	1500A	x15.0	x300.0
	1600A	x16.0	x320.0
	2000A	x20.0	x400.0
	3000A	x30.0	x600.0
	3200A	x32.0	x640.0
4000A	x40.0	x800.0	
FOR 240V (Split-Phase)	100A	x0.5	x20.0
	200A	x1.0	x40.0

Table 1. CT Multipliers

REVISIONS			
REV.	DESCRIPTION	DATE	APPROVED

		Quadlogic Controls Corporation	TITLE	
SIGNATURES		DATE	1-PHASE, 3-WIRE 120/208V WIRING NETWORK DIAGRAM 	
MODEL	JREA	07/09/08	SIZE	DRAWING
APPROVED	RSAN	07/10/08	17-MC5c120RES2ELCDNR1	
APPROVED	JKIM	07/10/08	SCALE:	REV 1.1.R
APPROVED	BDAU	07/10/08	SHEET 3# 3	

INSTALLATION NOTES

Applicable for the following catalog numbers ¹:

MC5c240VX * 06R (CDN 2EL/06M 240VX 1P3W)

MC5c240VX * 12R (CDN 2EL/12M 240VX 1P3W)

* = "L" for 0.1 Amp inputs or "H" for CL10 (5 Amp) inputs.

¹ Also applicable when the same meter model number has the suffix: M, RS or P.

CRITICAL: The line association and polarity of the current transformers must be followed or meter will not be installed correctly.

CTs must be all 0.1A or 5A and cannot be mixed on the same meterhead.

1. Each CT has a white side, small white dot, or "H1" marking on only one side of its exterior moulding. Locate this marking since it is critical that the wires are passed through the CT in the correct direction, assuring the correct polarity.

Two wires coming from the line side are passed through each CT.

Line 1 (Wire 1): Line 1 should be passed through the CT from the side with the white side, dot, or H1 marking.

Line 2 (Wire 2): Line 2 should be passed through the CT from the side WITHOUT the white side, dot, or H1 marking. Note that these are opposite polarities.

2. The MCI runs CT terminals CT#1 to CT#24 with each terminal connected to Meter #1 (M#1) to Meter #12 (M#12). The number of CT terminal and meter connections will depend on the number of suites available. For example:

- M#1 connects to CT#1 and CT#2
- M#2 connects to CT#3 and CT#4
- repeat for M#3 to M#12

3. After completing all CT terminations, connect the four (4) current connectors from the MCI board to the meterhead and then remove shorting links for all meter points that are in use.

4. Follow local codes for installation requirement, e.g. conduit, fused disconnect, distance, and wiring.

5. Installation of 0.1A ("L") inputs and CL10 or 5A ("H") inputs are the same.

CAUTION: If breakers are energized, shorting links must be installed before:



- a) disconnecting the CT headers or
- b) replacing or installing meter heads on the panel.

WARNING: Bodily injury or damage may result if shorting links are not installed.

Meter # (M#)	MCI Board CT #	Reference Voltage Line*
1	1	LINE 1
	2	LINE 2
2	3	LINE 1
	4	LINE 2
3	5	LINE 1
	6	LINE 2
4	7	LINE 1
	8	LINE 2
5	9	LINE 1
	10	LINE 2
6	11	LINE 1
	12	LINE 2
7	13	LINE 1
	14	LINE 2
8	15	LINE 1
	16	LINE 2
9	17	LINE 1
	18	LINE 2
10	19	LINE 1
	20	LINE 2
11	21	LINE 1
	22	LINE 2
12	23	LINE 1
	24	LINE 2

*Note: Line #1 points toward DOT or H1 of CT
Line #2 points away Dot or H1 of CT

Table 1. Line Association Table

 Quadlogic Controls Corporation		TITLE	
SIGNATURES		DATE	
MODEL	JREA	07/09/08	
APPROVED	RSAN	07/10/08	
APPROVED	JKIM	07/10/08	
APPROVED	BDUA	07/10/08	
1-PHASE, 3-WIRE 240V 2EL WIRING DIAGRAM			
SIZE	DRAWING	REV	
17-MC5c240RES2ELCDNR1		1.1.R	
SCALE:		SHEET 1 of 3	

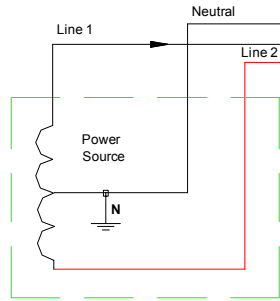

CRITICAL - Current Transformers (CT) must be installed correctly. See Diagram 1 for CT installation for each meter point. See Diagram 3 for CT polarity and Table 1 for Phase Association relationships.

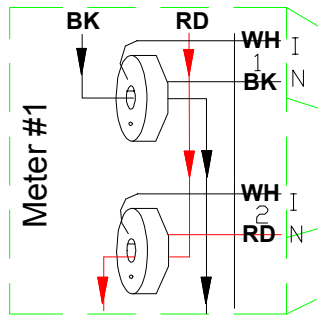
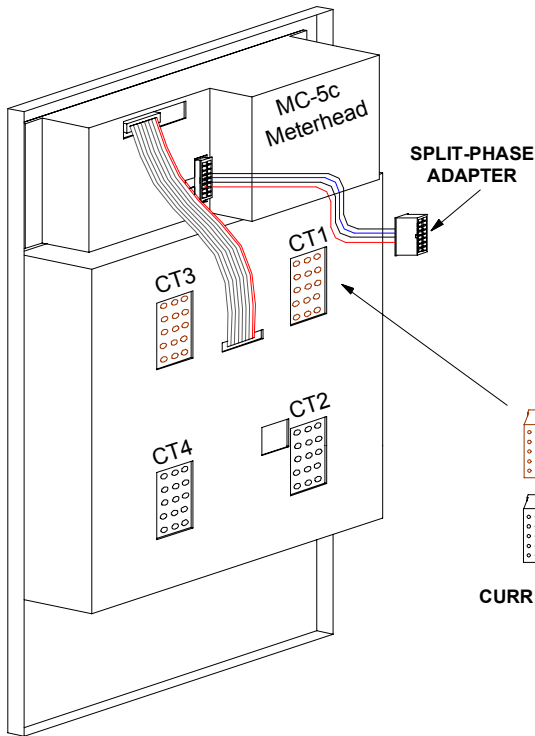

Diagram 1. Current Transformers installed inside tenant breaker panel.
Note: Conductor for each LINE 2 must be run reverse (backwards) through CT.

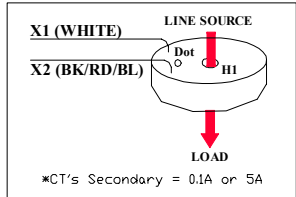
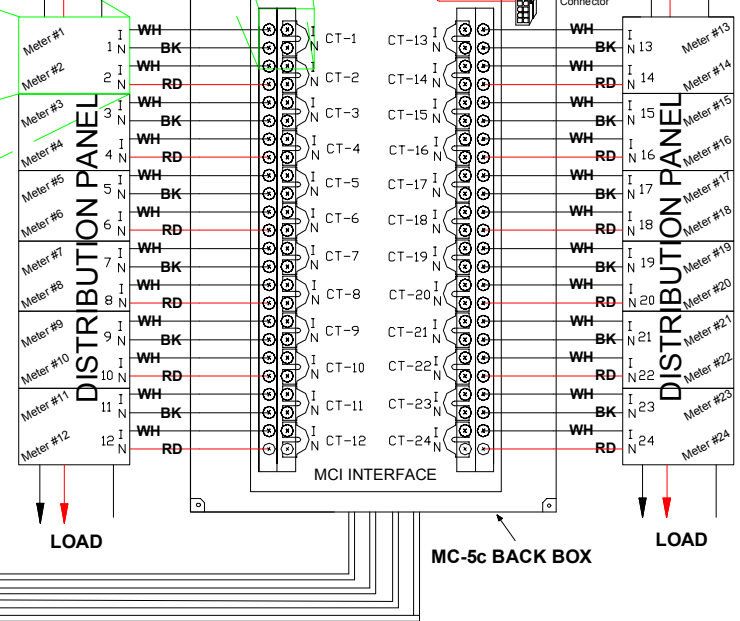
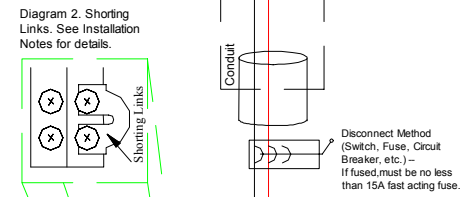

Diagram 3. CT Phasing. Dot or H1 should point towards the line or source.

		Quadlogic Controls Corporation TITLE 1-PHASE, 3-WIRE 240V 2EL WIRING DIAGRAM		
SIGNATURES MODEL: JREA APPROVED: RSN APPROVED: JKIM APPROVED: BDU		DATE: 07/09/08 DATE: 07/10/08 DATE: 07/10/08 DATE: 07/10/08		
SIZE: DRAWING 17-MC5c240RES2ELCDNR1		REV: 1.1.R		SHEET 2 of 3

BEFORE READING THE DISPLAY FOR ANY MC5 PRODUCT

CAUTION: When reading the meter display, all consumption and demand values must be multiplied by the correct multiplier to calculate true value. This includes all register values (kWh, kW, kVARHLg, kVARHLd, etc.) and Phase Diagnostic values (real time Amps, Watts, etc.).

Volts, phase angle, frequency and power factor are displayed on the LCD as their true values and should not be multiplied.

The multiplier value is dependent upon the ratio of the external Current Transformers (CTs) and can be different for different meter points. Please consult Table 1 CT Multipliers for the appropriate value dependent upon the rating (or size) of the CT.

HOW CT MULTIPLIERS ARE CALCULATED:

0.1AMP CTs

The multiplier values for CTs with 0.1A secondary ratings are derived by dividing the primary side rating by 100. For example, a 50:0.1A-rated CT will have a multiplier of $50 \div 100$, which is 0.50. A 100:0.1A rated CT will have a multiplier of $100 \div 100$ which is 1.)

5AMP CTs

For CTs with 5A secondary ratings, the multipliers are derived by dividing the primary side rating by 5. For example, a 200:5A-rated CT will have a multiplier of $200 \div 5$, which is 40.

EXAMPLE:

Meter point with 400:0.1A CT

LCD reading for meter is 3422.119kWh

The correct cumulative consumption (kWh) for this meter is **13688.476** kWh.

($400 \div 100 = 4$. Multiply face value for consumption and demand values by 4. $3422.119 \times 4 = 13688.476$)



NOTE: Failure to use the appropriate multiplier will result in an incorrect diagnosis of the meter's functionality and incorrect revenue billing.

Meter Voltage Ratings	CT Rating	Multiplier for 0.1A CT	Multiplier for 5.0A CT
FOR 120V, 208V, 240V (Wye) 277V, 347V, 416V, 480V, 600V	50A	x0.5	x10.0
	100A	x1.0	x20.0
	200A	x2.0	x40.0
	400A	x4.0	x80.0
	600A	x6.0	x120.0
	800A	x8.0	x160.0
	1200A	x12.0	x240.0
	1500A	x15.0	x300.0
	1600A	x16.0	x320.0
	2000A	x20.0	x400.0
	3000A	x30.0	x600.0
	3200A	x32.0	x640.0
	4000A	x40.0	x800.0

FOR 240V (Split-phase)	100A	x0.5	x20.0
	200A	x1.0	x40.0

Table 1. CT Multipliers

REVISIONS			
REV.	DESCRIPTION	DATE	APPROVED

 Quadlogic Controls Corporation		TITLE	
SIGNATURES		DATE	
MODEL	JREA	07/09/08	
APPROVED	RSAN	07/10/08	
APPROVED	JKIM	07/10/08	
APPROVED	BDUA	07/10/08	
1-PHASE, 3-WIRE 240V 2EL WIRING DIAGRAM 		SIZE	DRAWING
17-MC5c240RES2ELCDNR1			REV 1.1.R
SCALE:		SHEET 3 of 3	