

PilotAware P3I Protocol

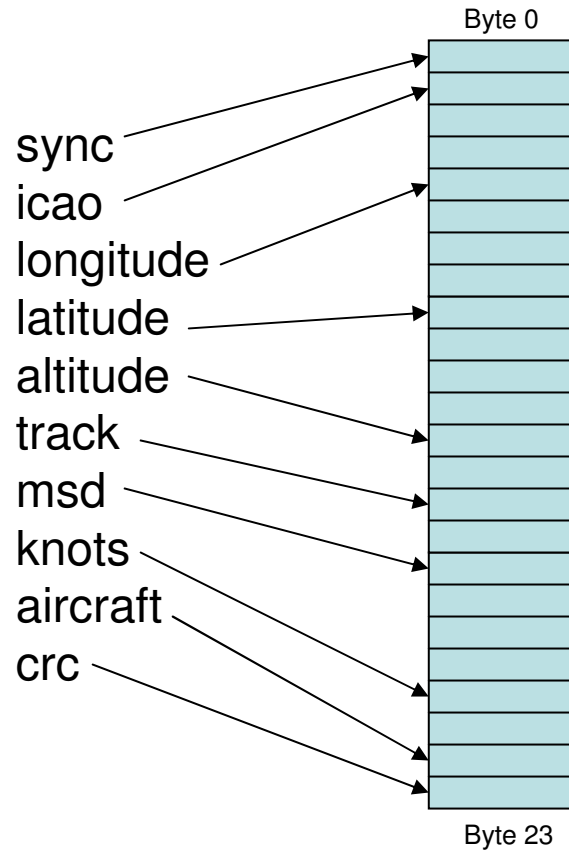

P3i: OpenP3iProtocol

24 byte
Packet

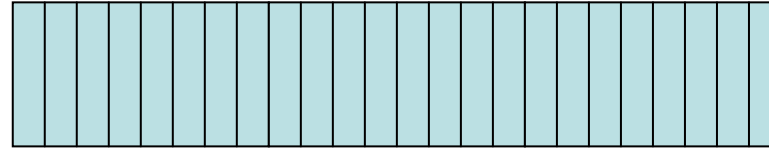

P3i: OpenP3iProtocol sync

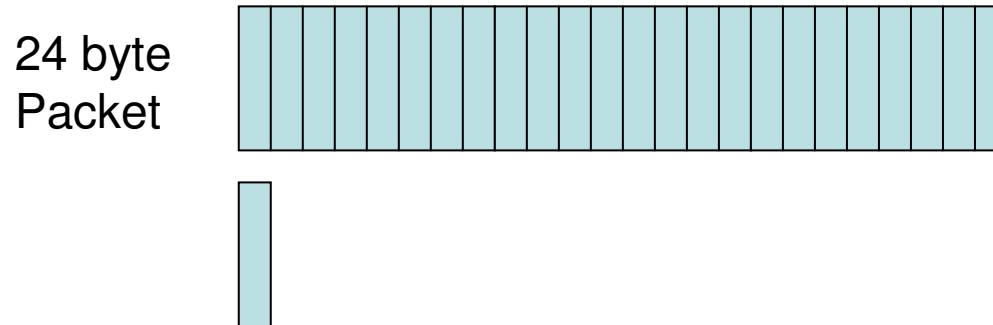

The sync character is a single character Identifier, indicating the start of a 24 byte Packet of data. The chosen character is '\$', this conforms with the GPS NMEA Standard for a '\$' meaning start of line, eg \$GPGGA ...

P3i: OpenP3iProtocol icao

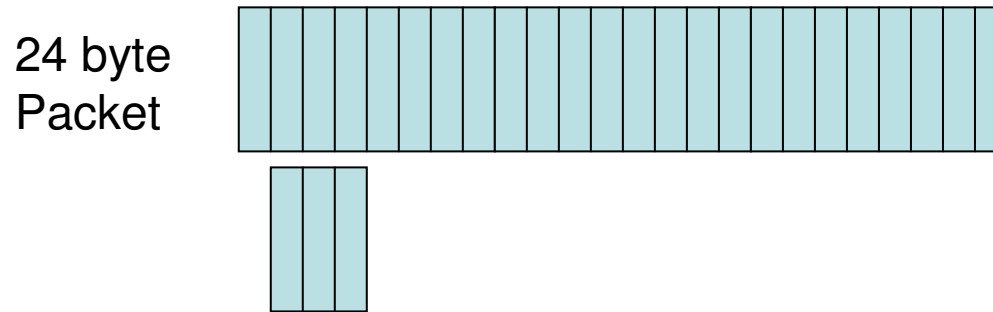

The icao field is a 24bit value which is used
As a unique identifier over the air, this can
Be the same value used for the transponder
Or a pseudo random identifier, an example
Of an icao would be 0x40526F

P3i: OpenP3iProtocol longitude/latitude

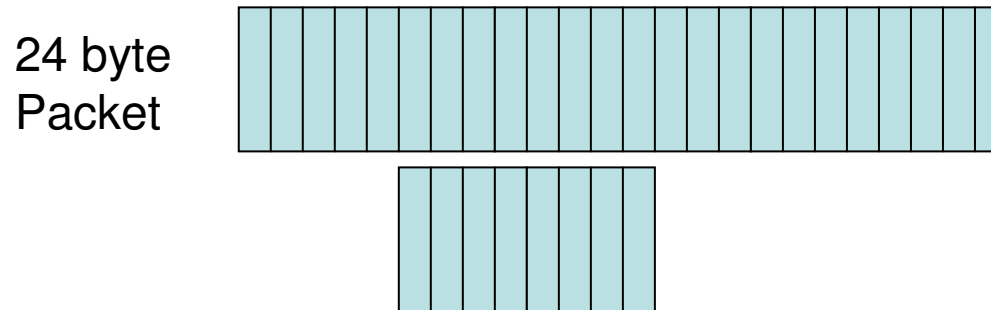

The longitude and latitude values are encoded
As decimal degrees, encoded into a 32-bit
Floating point number, as specified by
IEEE-754 single precision

- Bit[31] - Sign
- Bit[30:23] - Exponent
- Bit[22:0] - Mantissa

Note: 64-bit double number representation would be more accurate,
But in reality the inaccuracy due to a 32-bit representation, is so
Small it is not worth consideration.

P3i: OpenP3iProtocol altitude

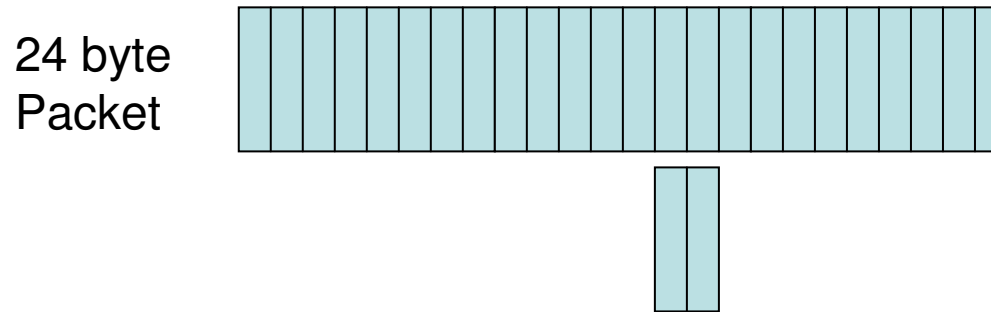

The altitude value is encoded using GPS representation
As an unsigned 16 bit value. Although the packet representation
is in metres, the Displayed value is likely to be feet, giving the
Following vertical range
range: 0ft - 215,000ft (AMSL)

P3i: OpenP3iProtocol track

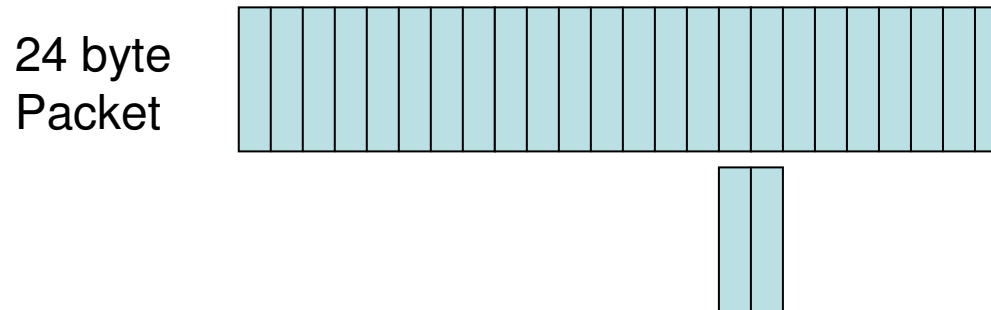

The track indicates the aircrafts track vector
In degrees Relative to true north. Encoded as
an unsigned 16 bit value, this represents the
required track of 0 – 359

Note: This is a little bit of overkill as the data can represent
0 – 65535, it may be worthwhile breaking this down into a
Smaller structure of

Bit[15:9]	- reserved (7 bits)
Bit[8:0]	- track (0-511) (9 bits)

P3i: OpenP3iProtocol

msd (message sequence data)

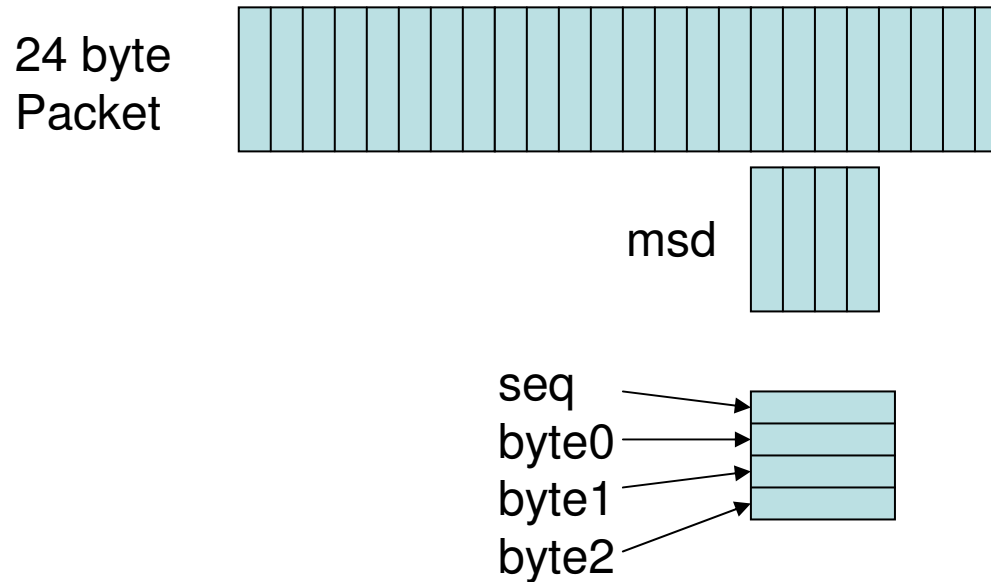

This is a much more complicated structure than the previous fields. This provides the ability to split a large piece of data over Many packets of information. The seq(ue)nce indicator, provides an index into an array of data for the subsequent bytes 0-2. The sequence has a range of 0-255, meaning upto 768 bytes of Data can be transferred over consecutive packets

P3i: OpenP3iProtocol knots

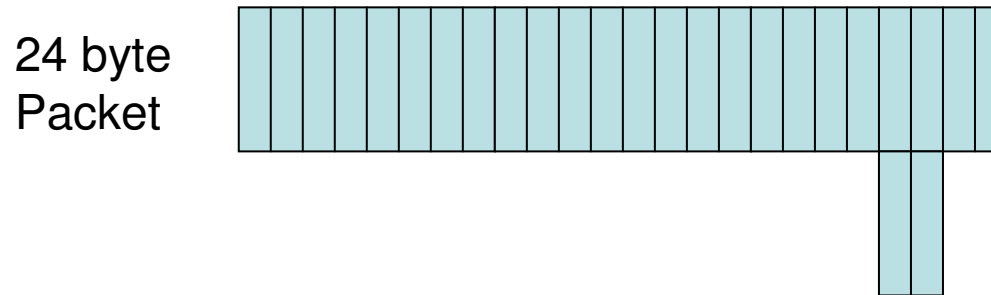

The knots field indicates the ground speed of the Aircraft in knots. As an unsigned 16 bit value, this Gives a range of 0 – 65535 knots

Note: This is a little bit of overkill as the data can represent 0 – 65535, it may be worthwhile breaking this down into a Smaller structure of

Bit[15:11]	- reserved (6 bits)
Bit[9:0]	- track (0-1023) (10 bits)

P3i: OpenP3iProtocol aircraft

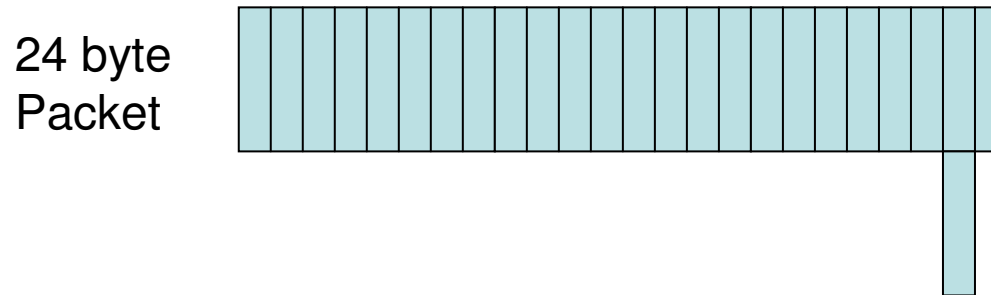

This field indicates the aircraft type, and has a Range of 0-255, which means we could represent 256 types of aircraft.

Groundstation, microlight(flex), microlight(3-axis), Helicopter, paramoter, glider, motor-glider, balloon, Parachute, drone?

P3i: OpenP3iProtocol

crc

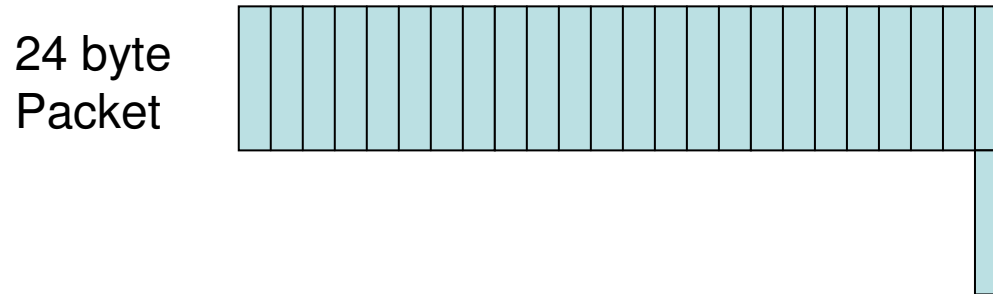

This is a simple cyclic redundancy checker
Used on the packet data from 0:22 bytes
If the CRC generated locally agrees with the
CRC at the end of the packet, the packet
Is deemed to be valid, else it is discarded

P3i: OpenP3iProtocol

The plan is for every plane to transmit a single packet of information at about 2 second intervals. This is at a data rate of 38.4kb/s

The greater the data rate, the less likely interference, but receiver sensitivity is likely reduced, consider the over the air bandwidth as a series of trains

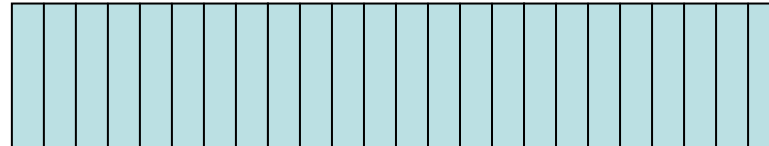

P3i: OpenP3iProtocol

38.4k baud

38400baud = 1bit/26uS

24 bytes = 192 bits = 5ms

1.6 - 1.8 second repeat

At 1.6 second repeat Duty Cycle=0.31%

At 1.8 second repeat Duty Cycle=0.27%